



SERVICE PARTS LIST

BULLETIN NO.
54-07-2305

SPECIFY CATALOG NO. AND SERIAL NO. WHEN ORDERING PARTS		REVISED BULLETIN	DATE
FLUORESCENT LIGHTING TESTER			Sept. 2011
CATALOG NO.	2210-20	SERIAL NUMBER	D61A
WIRING INSTRUCTION			

EXAMPLE:

00	0
----	---

 Component Parts (Small #) Are Included
 When Ordering The Assembly (Large #).

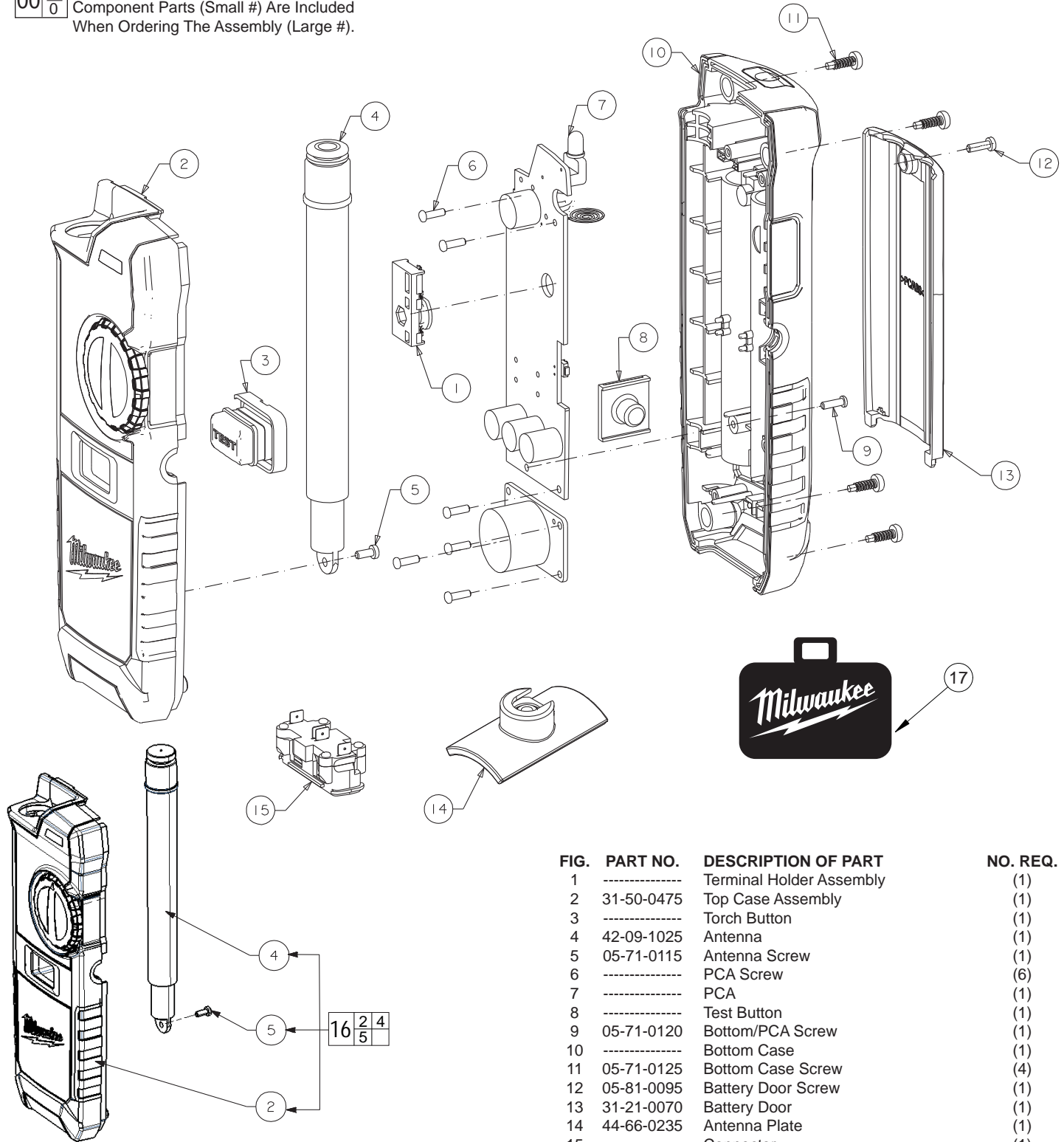

FIG.	PART NO.	DESCRIPTION OF PART	NO. REQ.
1	-----	Terminal Holder Assembly	(1)
2	31-50-0475	Top Case Assembly	(1)
3	-----	Torch Button	(1)
4	42-09-1025	Antenna	(1)
5	05-71-0115	Antenna Screw	(1)
6	-----	PCA Screw	(6)
7	-----	PCA	(1)
8	-----	Test Button	(1)
9	05-71-0120	Bottom/PCA Screw	(1)
10	-----	Bottom Case	(1)
11	05-71-0125	Bottom Case Screw	(4)
12	05-81-0095	Battery Door Screw	(1)
13	31-21-0070	Battery Door	(1)
14	44-66-0235	Antenna Plate	(1)
15	-----	Connector	(1)
16	14-46-0405	Housing/Antenna Kit	(1)
17	42-55-0175	Soft Carrying Case	(1)